



## VERDERAIR **PRODUCT RANGE**

VERDERAIR PURE | VERDERAIR STANDARD | VERDERAIR HI-CLEAN | VERDERAIR EODD  
VERDERAIR CONT-EX | SPECIAL PUMPS | ACCESSORIES



### Benefits

- Increase productivity
- Reduce operational cost
- Improve working environment

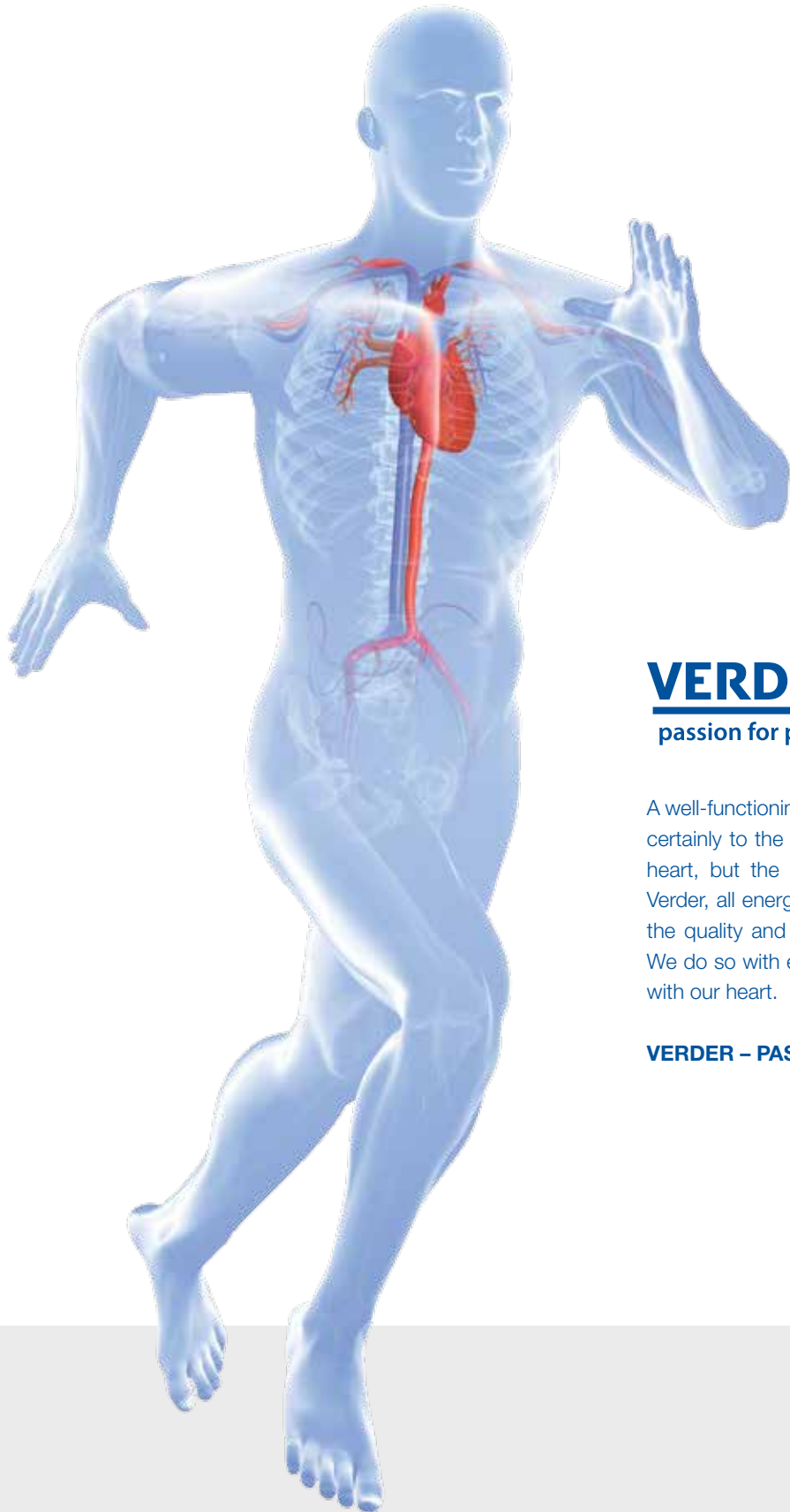

## **VERDER**

passion for pumps

A well-functioning pump helps you succeed. That applies certainly to the most important pump in life, the human heart, but the same goes for pumps in business. At Verder, all energy and attention is focused on improving the quality and performance of our pump and service. We do so with energy, dedication and most importantly, with our heart.

**VERDER – PASSION FOR PUMPS**



## THE VERDER GROUP

- 1 Company
- 26 Countries
- 55 Years of expertise
- Global network
- Local distributors
- In-house service & maintenance
- A solution for every application

*The Verder group is a family owned business formed over 55 years ago in the Netherlands; the group consists of a worldwide network of production and distribution companies. Group companies are involved in the development and distribution of industrial pumps, pumping systems, high-tech equipment for quality control, research and development into solid material (solids sample preparation and analytical technologies). The Verder Group employs over 1600 people and has an annual turnover in excess of 380 million Euros.*

Among the most successful of Verder's technologies is its innovative Verderflex, peristaltic hose and tube pumps range.

### Verderair double diaphragm pumps

*Verderair is a core Verder group product, solving pumping problems in such varied industries as: chemical manufacturing, food production, environmental remediation, chemical and processing industries, as well as general manufacturing and Original Equipment Manufacturing.*

Verderair double diaphragm pumps are manufactured in the EU. There are series available with specified food grade certificates, solid machined heavy duty pumps, hygienic series, and electric driven double diaphragm pumps.

Verderair double diaphragm pumps are the ideal solution for almost all liquids, also for very demanding applications. The series range from smaller OEM pumps to high flow industrial series.



## VERDERAIR **DOUBLE DIAPHRAGM PUMPS**



*Verderair double diaphragm pumps are used with a variety of fluids. These pumps are the best solution for applications that are of abrasive or corrosive nature. Also very sticky and viscous liquids, or liquids containing solids can be handled without problems. The quick acting air valve technology is making these pumps the most efficient diaphragm pump series on the market.*

### How does a double diaphragm pump work?

An air operated double diaphragm pump has two diaphragms. These diaphragms are connected by a shaft in the center section. The diaphragms are working as separation wall between the air and the liquid. The air valve is located in the center section of the diaphragm pump.

The air valve directs the compressed air to the back of diaphragm number one. In this way diaphragm number one moves away from the center section. This diaphragm causes a press stroke moving liquid out of the pump. At the same time diaphragm number two is performing a suction stroke.

### Verderair **Performance Overview**

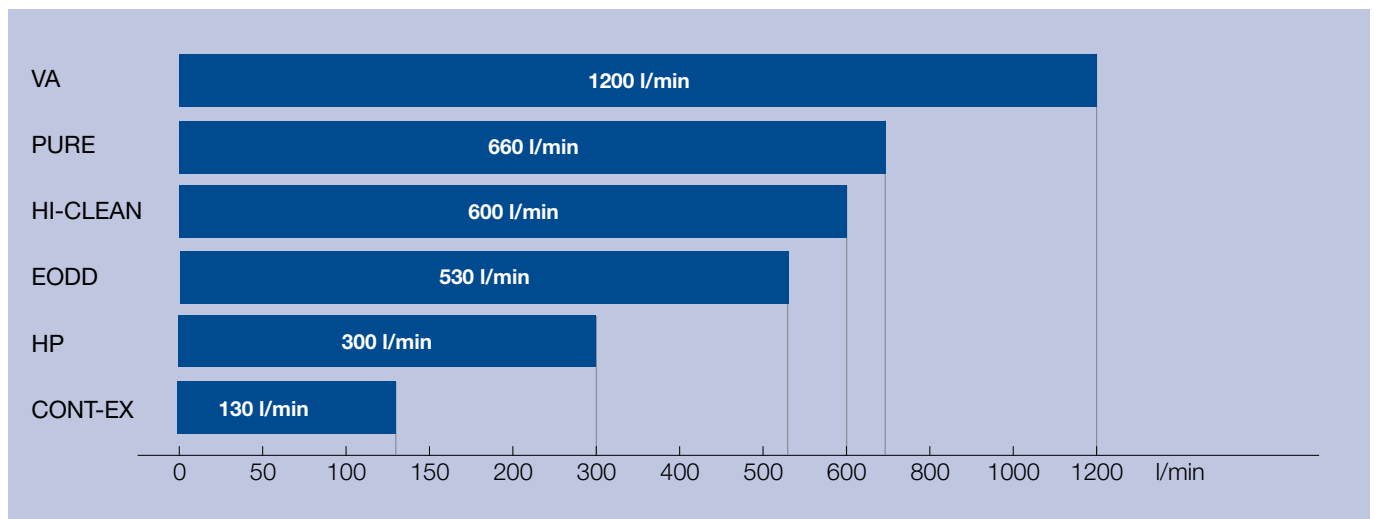

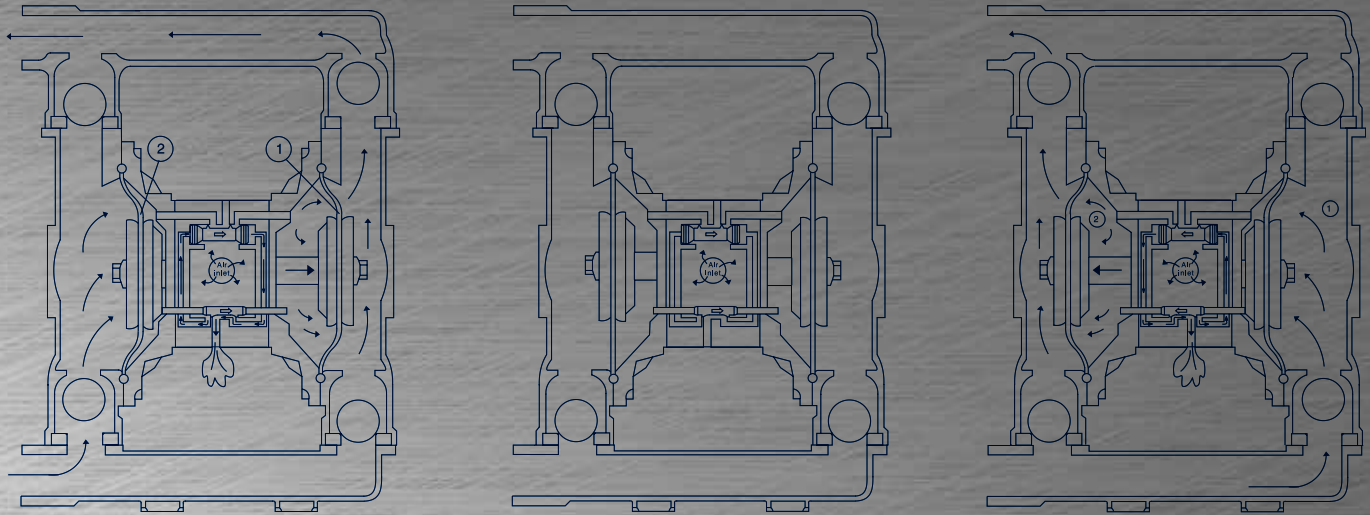

The air behind diaphragm number two is being pushed out to the atmosphere. Atmospheric pressure pushes the liquid to the suction side. The suction ball valve is being pushed away off its seat. This allows the fluid to flow along the ball valve into the liquid chamber.

When the pressurized diaphragm number one has reached the end of its stroke, the movement of the air is switched from diaphragm number one to the back of diaphragm number two by the air valve. The compressed air pushes diaphragm number two away from the center block. Doing so, diaphragm number one is pulled toward the center block. In pump chamber number two the discharge ball valve is pushed off its seat. In pump chamber number one the opposite occurs. Upon completion of the stroke the air valve leads the air again to the back of diaphragm number one and restarts the cycle as described above.

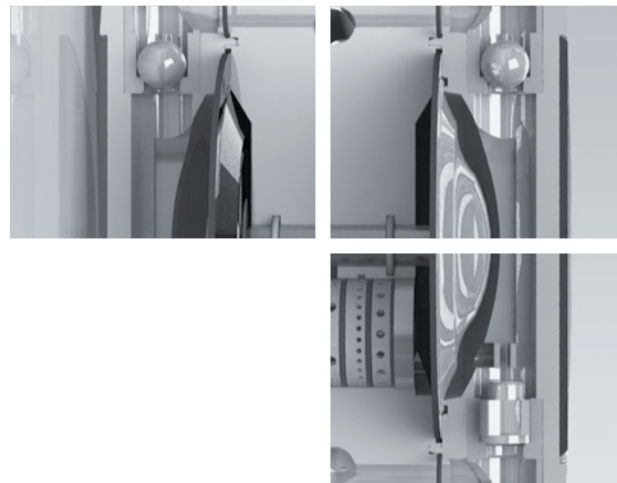

## What are **your benefits** using a Verderair double diaphragm pump?

Verderair pumps are reliable pumps. Less maintenance and less downtime for your process. The three core elements of every Verderair pump are:

### Increase productivity

*Higher flow rate, less maintenance*

*Low 'pressure drop' when the liquid passes the pump chamber. Smoother flow, increased efficiency pumping the liquid. The diaphragms have a special profile which is designed for an extremely long working life.*

### Reduce operational cost

*Lower air consumption*

*The quick-acting air valves are very fast in changing direction. No compressed air enters the air chamber when the stroke has completed. The used compressed air is removed with almost no restrictions. The compressed air is only used to move the liquid.*

### Improve working environment

*Less noise*

*By using all of the compressed air the pump makes less noise and the risk of freezing the exhaust is reduced.*

# VERDERAIR **PRODUCT RANGE**

## An overview



### **VERDERAIR STANDARD**

*The allrounder of the AODD Pumps*

- Wide range of different materials available
- Quick acting air valve technology guarantees highest efficiency
- Bolted chambers for safe operation and easy maintenance
- Anti-ice mufflers standard on HE range
- Overmolded diaphragms available for longer lifetime



### **VERDERAIR CONT-EX**

*The small AODD for OEM and demanding applications.*

- Compact design
- Machined out of solid UHMW PE Conductive
- 100% oil and grease free air valve
- 4 sizes available
- Cylinder valves for better suction lift available





### VERDERAIR EODD

*The allrounder but with electrical drive.*

- Electrically driven
- Same liquid parts as the VA range of pumps
- Long life-time diaphragms due to center section technology
- Can stall against closed discharge
- Low pulsation mode

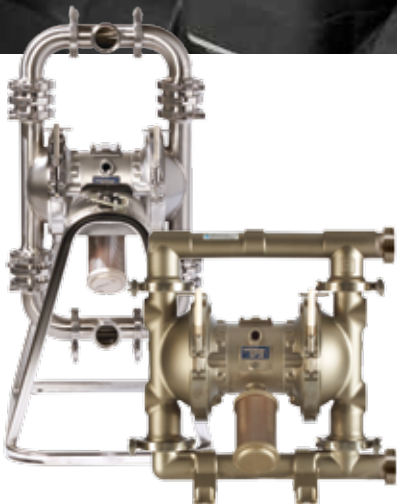

### VERDERAIR HI-CLEAN

*The performer for food and cosmetic applications*

- According to EN1935/2004 & FDA
- Strip cleaning: Fast disassemble
- CIP/SIP
- DIN 11851 or Tri-Clamp connections
- 3.2µm – 0.8 µm polished surface finish



### VERDERAIR PURE

*Top level AODD Pumps*

- Machined out of 100% PURE PTFE or UHMW PE
- Solid design for perfect pressure holding & limited vibrations
- 100% oil and grease free air valve
- Available with several safety options
- No metal wetted or external parts



## THE HEART OF YOUR DOUBLE DIAPHRAGM PUMP: **THE AIR VALVE**

*The heart of your double diaphragm pump is the air valve. Comparable with the heart of the human body, the efficiency of your diaphragm pump is depending on the quality of air valve of the pump. Sometimes your pump has to run slow and steady for a long period, sometimes you want a quick fluid transfer. With this in mind, VERDERAIR has developed 3 different kind of air valves, with their specific features, to make the best out of air operated double diaphragm pump.*

### General features

- ✓ Non-stalling
- ✓ No air lubrication needed
- ✓ Easy maintenance
- ✓ No freezing

### Standard Air Valve

*(Used on VA standard and HI-CLEAN)*

*Cup and plate design air valve. Reliable air valve which has proven his functionality over the years.*

- ✓ Built from 9 parts
- ✓ Assembly inside the center block
- ✓ Proven design



### Quick Acting Air Valve

*(Used on VA standard HE versions)*

*Modular cup and plate design air valve. The most efficient on the market.*

- ✓ Built from 13 parts
- ✓ Externally serviceable
- ✓ The "sprinter" under the air valves



### PURE Air Valve

*(Used on VA PURE & CONT-EX)*

*Cartridge design to work in the most severe environments.*

- ✓ Cartridge design
- ✓ Assembly inside the center block
- ✓ 100% self-lubricating





## VERDERAIR MATERIALS TO CHOOSE FROM

To meet most severe processes

To meet your most severe process conditions, yet still having a trouble-free operation, Verderair pumps have nine different material options for the valve seat, diaphragm & balls. The combination of these high quality materials together with the choice of different pump materials give the optimum pump selection.

- ↳ **Acetal** – Wide range of solvent resistant and withstands extreme fatigue. Good level of abrasion resistance. Electrically conductive (ATEX).
- ↳ **Santoprene** – Good resistance to abrasive and chemical fluids. Santoprene is compatible with some solvents (e.g. Acetone, MEK), caustic solutions, dilute acids and alcohols.
- ↳ **Teflon** – (PTFE) Most compatible material for chemical applications, extremely resistant to corrosion and high temperatures, very low friction coefficient, non-adhesive.
- ↳ **Thermoplastic polyester** – (Hytre) Good performance properties at lower temperatures and good resistance to abrasive fluids. Thermoplastic polyester is often a substitute for Buna-N.
- ↳ **Fluorelastomers** – (Viton) High heat resistance. Good resistance to aggressive chemicals including acids and some solvents. (e.g. xylene and mineral spirits). Good resistance to steam as well as animal, vegetable and petroleum oils. Resists unleaded fuels.
- ↳ **Geolast** – Abrasion resistance. Approximately same chemical compatibility as Buna-N.
- ↳ **Polychloroprene** – (Neoprene) Good chemical resistance, good performance with oils and many chemicals, good temperature resistance, outstanding physical toughness, outstanding resistance to damage caused by flexing and twisting. Resistance to abrasion is approximately 30% higher than Buna.
- ↳ **EPDM** – Good water and chemical resistance. Not for use with oils, greases and most solvents.
- ↳ **BUNA** – Good for petroleum-based fluids, water, oils, hydrocarbons and mild chemicals (e.g. mineral spirits).



## VERDERAIR **PURE**

Solid machined double diaphragm pumps



The Verderair PURE double diaphragm pump is a robust series of double diaphragm pumps, produced from one-piece solid material. The Verderair PURE is designed for heavy-duty operation, also for harsh liquids and severe process conditions, such as operating in power plants and refineries.

The Verderair PURE has all the benefits of a Verderair double diaphragm pump such as increased productivity through a higher flow rate and reduced operational cost because of lower air consumption.

On top of that the PURE series has an extended program of accessories. Thanks to the efficient operation less maintenance is needed. Improved working environment is realized because the pump makes less noise.

The Verderair PURE is available in 4 wetted part materials; each pump being made from one solid piece of the purest and finest PTFE or PE.

mm	VA-P08	VA-P10	VA-P15	VA-P25	VA-P40	VA-P50
Connections	8	10	15	25	40	50

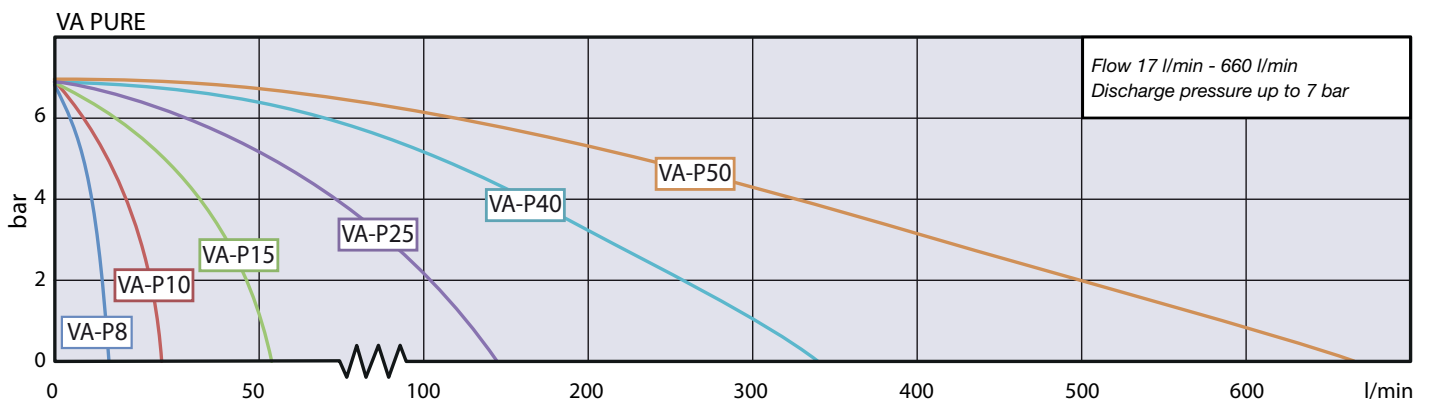



## VERDERAIR **PURE PULSATION DAMPENERS**

To reduce a pulsed flow

*Due to the function principle, air operated double diaphragm pumps are generating a pulsating flow. By using a Verderair pulsation dampener in combination with the pump, the flow pulses will be reduced to the minimum.*

The Verderair pulsation dampeners are active dampeners and achieve the best possible dampening effect to create an almost flat flow.

mm	PD-P8*	PD-P10*	PD-P15	PD-P25	PD-P40	PD-P50
Connections NPT male thread or combi flanged	8	10	15	25	40	50

\* not available with flanged connection

### Accessories for VA PURE pumps:

Verder offers an extended line of accessories for Verderair PURE pumps.

- ↪ Stroke Sensor: with electrical or pneumatical sensor
- ↪ Remote Operated Pump: to control the stroke frequency
- ↪ Manual Draining: to evacuate the remaining liquid on top of the valves manually
- ↪ Pneumatical Draining: with 4/2 electro-pneumatical valve, the draining system can be activated by an electrical signal
- ↪ Barrier System: double liquid chambers and double diaphragms at each side to protect the environment from diaphragm rupture
- ↪ Leak Detection: by a capacity sensor to detect diaphragm failure

### Materials for Verderair PURE and PURE Pulsation Dampeners

#### ↪ Polyethylene (PE)

Extremely abrasion resistant. Upto 7 times better than Polypropylene. Chemical resistance is compatible to Polypropylene.

#### ↪ Conductive Polyethylene

Similar properties to Polypropylene but conductive for ATEX applications.

#### ↪ Teflon (PTFE)

Widest chemical compatibility, extreme corrosion resistance, very low frictional coefficient, non adhesive, high heat resistance.

#### ↪ Conductive teflon

Similar properties to PTFE, but electrically conductive for ATEX applications.

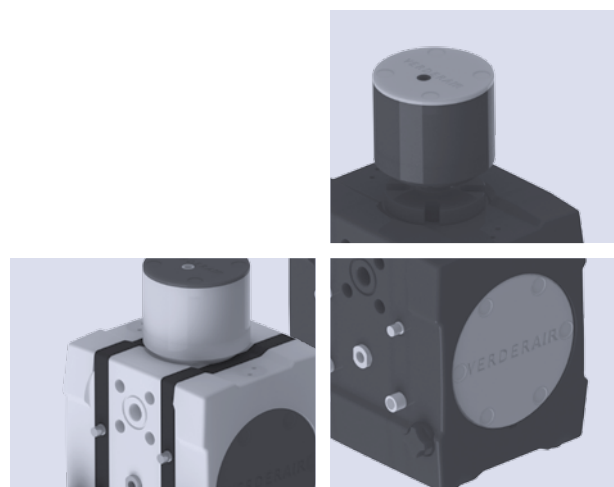



## VERDERAIR VA METALLIC

Standard solutions for various industries



The Verderair VA metallic series of diaphragm pumps is used throughout industry for various media such as paints and solvents, waste water (or mixtures of water & chemicals), oil and lubricants.

In applications such as oil transfer, oil skimming and chemical plating a Verderair metallic diaphragm pump is an excellent choice; as well as for filter press applications, transfer drum, tank stripping and unloading fluids, and many more.

### Materials

- ↳ **Aluminium** – General purpose material. Good for solvent based coatings and inks. Resistant to mild chemicals.
- ↳ **Cast Iron** – Highly abrasion resistant. Often used in paper, waste water industry and mining.
- ↳ **Stainless Steel 316** – Resistant to most acids, bases and solvents. Can handle halogenated hydrocarbons. Good resistance to abrasive media.

mm	VA-20	VA-25	VA-40	VA-50	VA-80
Connections	20	25	40	50	80

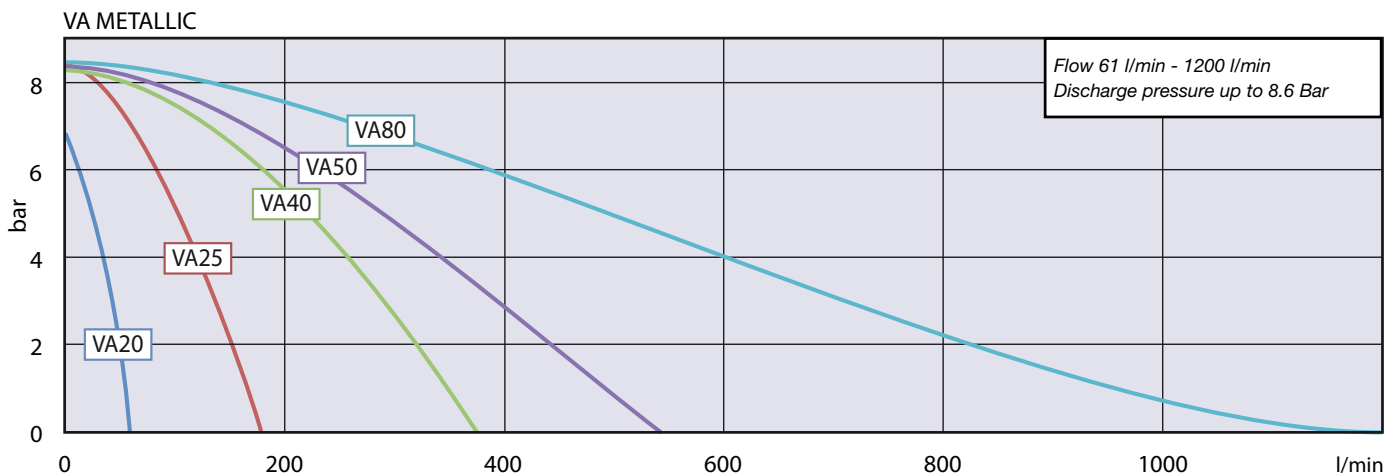

## VERDERAIR VA NON-METALLIC

Standard solutions for various industries



Verderair non-metallic double diaphragm pumps are excellent pumps for use in a wide range of applications across many industries. Depending on your medium or chemicals, fluid and process specifications, the best solution is selected. Application areas are amongst others paint & lacquer and chemical fluids.

Verderair VA offers four non-metallic materials to choose from. Conductive Polypropylene and Acetal can be used in ATEX rated zones. PVDF is the best choice for even the most chemically aggressive media.

### Materials

- **Polypropylene** – Has a wide chemical compatibility for general purpose applications; PP is limited temperature resistant.
- **Conductive polypropylene** – Similar to standard Polypropylene but electrically conductive (ATEX).
- **PVDF (Kynar)** – PVDF is the best choice for even the most chemically aggressive media.
- **Acetal** – Compatible with many solvent applications and can withstand extreme fatigue. Good resistance to abrasive media and is conductive for ATEX applications.

mm	VA-08	VA-10	VA-15	VA-25	VA-40	VA-50	VA-80
Connections	8	10	15	25	40	50	80

### Accessories for VA metallic and non-metallic pumps:

Verder offers an extended line of accessories for double diaphragm pumps.

- **Stroke Sensor:** to measure the number of strokes
- **Remote Operated Pump:** to control the stroke frequency
- **Leak Detection:** by a capacity sensor to detect diaphragm failure

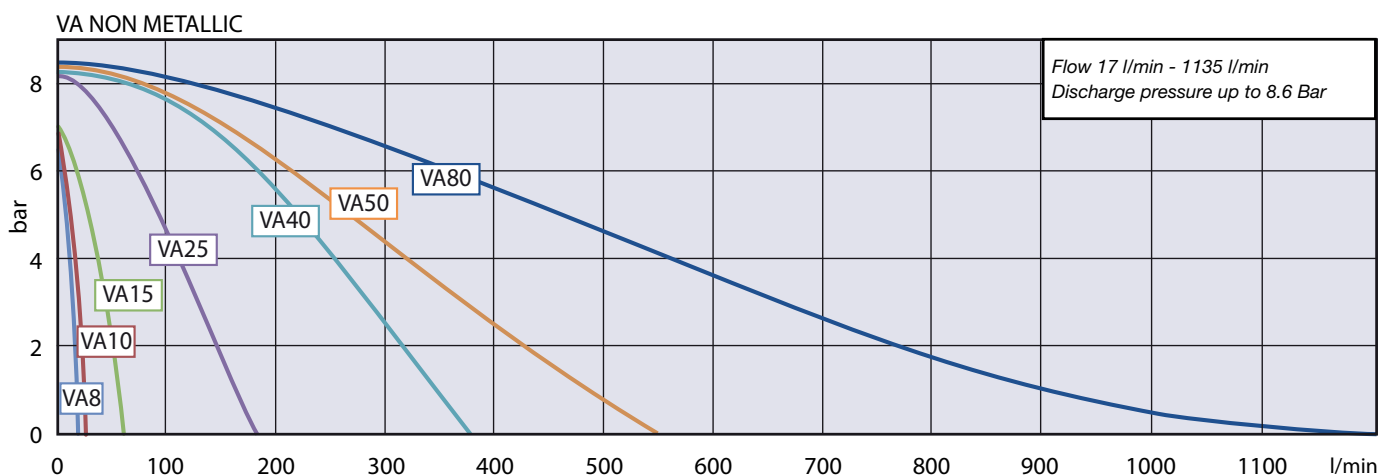

## VERDERAIR VA PULSATION DAMPENERS

To reduce a pulsed flow

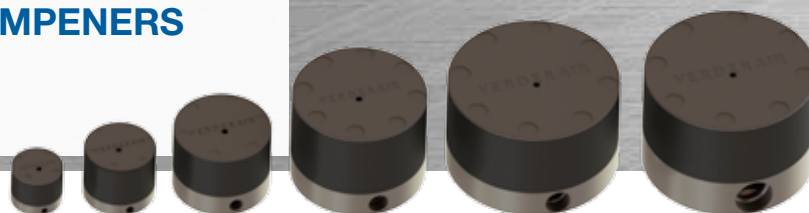

Air Operated Double Diaphragm Pumps have a pulsating flow. This will lead to vibrations and pipe-line losses due to the pressure changes in the discharge pipeline. In processes where pulsation in the fluid stream needs to be minimized, the Verderair PD-S dampeners can be used.

The Verderair pulsation dampeners are active dampeners and achieve the best possible dampening effect to create an almost flat flow. The technology is based on the Verderair PURE technology.

### Your benefits

- Less vibration in the installation
- Smoother flow
- Better accuracy of instrumentation in the discharge line
- Less maintenance cost of the pipework

### Materials

Fluid section:

- Aluminium
- Stainless Steel
- Conductive PE
- UHMW PE

Air section:

- Polyamide
- Conductive PE

mm	PD-S10	PD-S15	PD-S25	PD-S40	PD-S50	PD-S80
Connections BSP or NPT female thread	10	15	25	40	50	80



## VERDERAIR AIR CONTROL PRO

For controlled flow regulation

To have an optimum use and life-time of your AODD pump, Verderair has developed the AIR CONTROL PRO. This is a range of accessories to help you to regulate the flow of your AODD and to protect the air valve and the diaphragms against early failure.

### Filter - Regulator with semi automatic drain

The regulator will keep the compressed air pressure supply to your pump on a constant set pressure.



### Throttle Valve

By using this throttling valve in combination with a pressure regulator the pump can be regulated on even low flow rates by the volume (=flow) of compressed air.



### Soft Start Valve

This valve gives the pump the time to start up slowly and will increase the life time of your diaphragms.



### ON-OFF Valve

Manual or electrical operated.



### Flow Stop Valve with reset button to stop the pump when dry-running

This valve will stop the air-flow to your pump when the pump is running without liquid.



## VERDERAIR HI-CLEAN

Hygienic double diaphragm pumps



The Verderair HI-CLEAN pumps are designed for operation in hygienic, cosmetic and food processing applications, such as fruit syrups and concentrates, sauces and cosmetic creams. They are available with DIN 11851 or Tri-Clamp connections and are easy to clean manually (strip cleaning).

### HI-CLEAN FD Series

The Verderair HI-CLEAN FD range has a surface finish  $Ra < 3.2 \mu m$  for handling liquids in the beginning of the process.

### HI-CLEAN SB & SF Series

The SB and SF range are suitable for handling liquids in the final hygienic production stage. They have a surface finish of  $Ra < 0.8 \mu m$ . The SB and SF are not only easy to strip clean but are also CIP and SIP cleanable

mm	VA-H20	VA-H25	VA-H40	VA-H50
Connections (DIN11851 or Tri-clamp)	25	40	50	65*

\* only for FD series. For SB and SF series 40, 50 or 80 mm are available

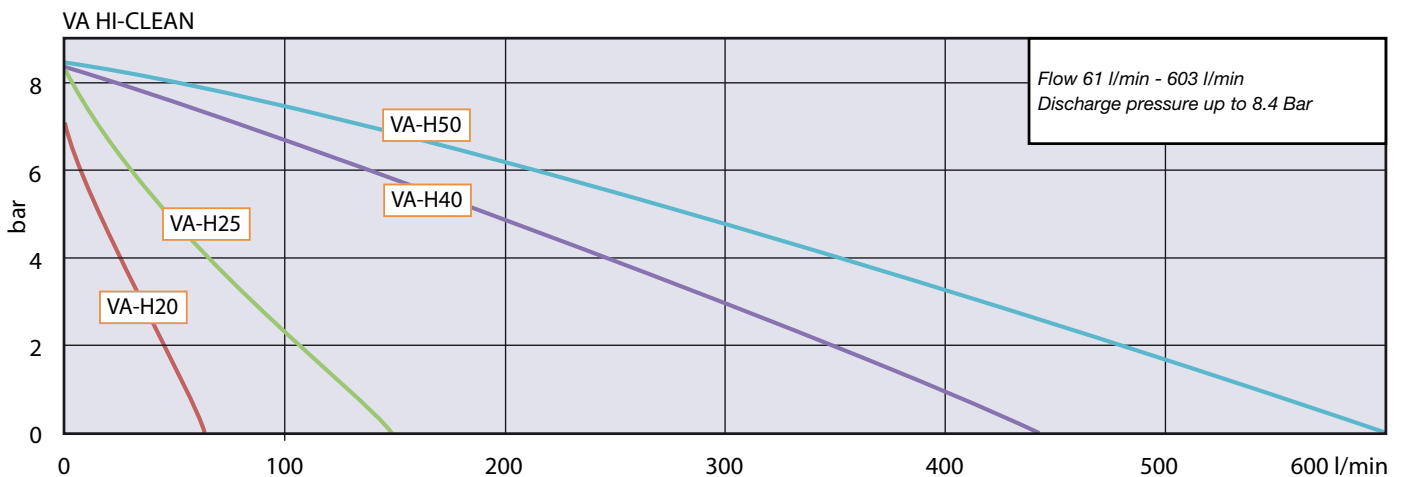



### HI-CLEAN SP Series

The SP range is a 1 : 2.5 piston pump range. This range is especially suitable to pump viscous media from standard drums of 200 litre, or cube containers from 1000 litre, to feed the production process.

mm	VA-H25
Discharge connection Tri-clamp*	25

\* DN25 DIN 11851 adaptor available

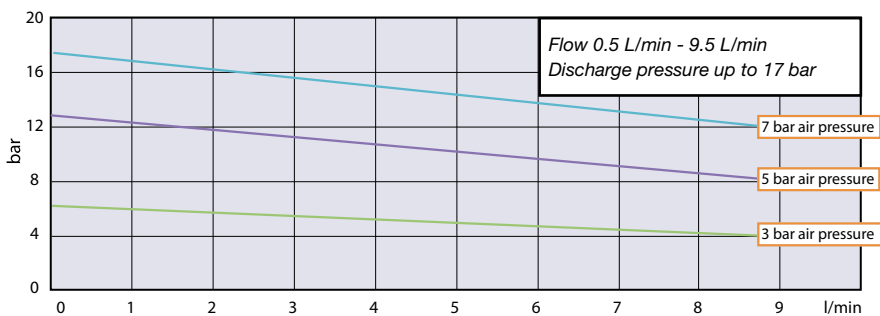

### HI-CLEAN Materials

- Stainless Steel 316, 3,2 µm surface finish – For use in food-grade applications (used in the FD and SP series).
- Stainless Steel 316, 0,8 µm surface finish – For use in high grade hygienic applications (used in SB and SF series).

### HI-CLEAN Certificates



## VERDERAIR EODD

Electronic driven double diaphragm pumps



### EODD Series

The Verderair EODD pumps (Electronic driven double diaphragm pumps) are a very energy-efficient pump solution. The pumps are ideal for applications that require low pulsation and a smooth flow. The pumps are available in metallic and non-metallic materials, to be tailored for applications demanding resistance to aggressive chemicals and abrasive fluids.

The patented "air cushion" system of the EODD series, makes it possible to run the pump against a close discharge, similar to the AODD series, without the need of an overpressure protection valve. In addition the pump can run in "low pulsation mode" so there is no need to use pulsation dampeners. The EODD pump range is available in an industrial and in a hygienic model; both in 1" or 2" execution.

An EODD pump is a very energy efficient solution. It reduces energy consumption up to 5 times compared to an AODD pump.

### Accessories

- *Integrated air cushion regulator*
- *Leak sensor*

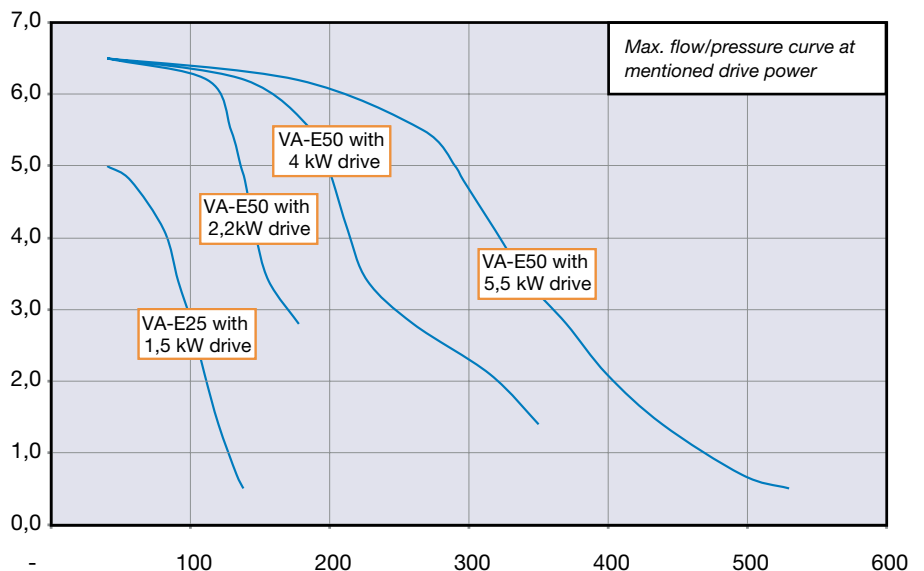

## VERDERAIR CONT-EX

All-purpose double diaphragm pumps



The CONT-EX pump is a OEM pump for middle flows and many different applications. The pumps are also used as barrel emptying pump.

The CONT-EX series of pumps are made from a solid block of conductive UHMW-PE. This series can be used in EX environments. The pump series combines are very high abrasion and corrosion resistant. Models available with ball and cylinder valves (for better dry suction lift).

### Key features:

- Solid machined air operated diaphragm pumps
- Made out of conductive polyethylene
- Available in 4 sizes (max flow 10 l/min, 20 l/min, 50 l/min, 130 l/min)  
ATEX certified
- Ball valves (for liquids containing particles) or cylinder valves (good suction lift)

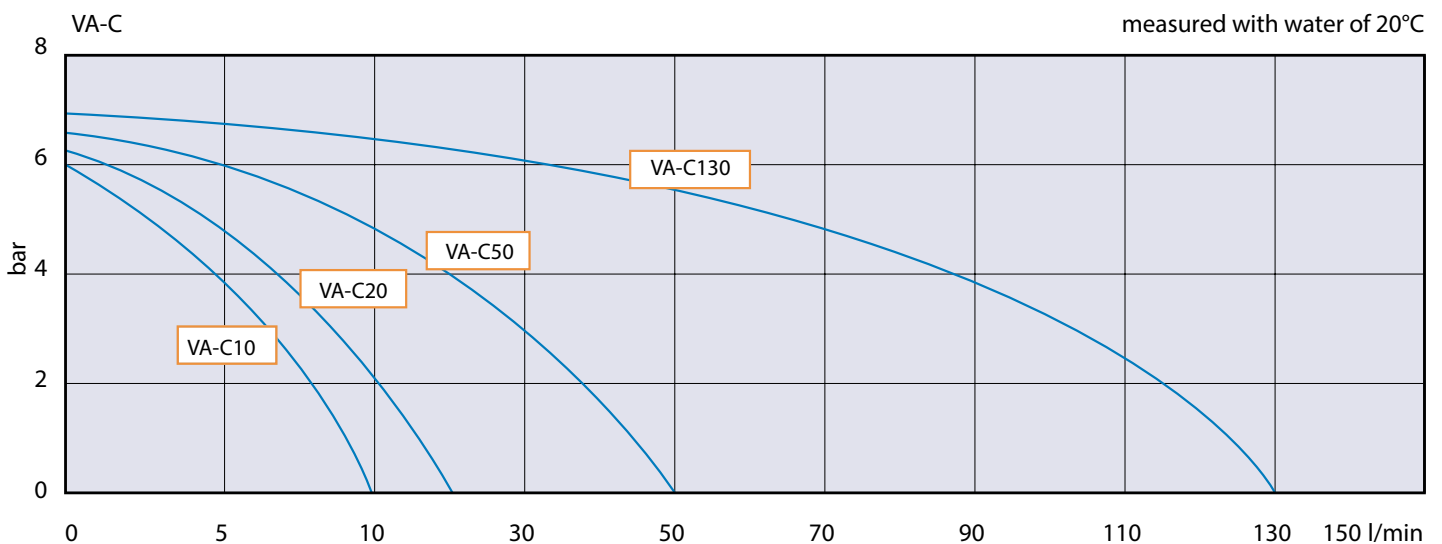

## VERDERAIR **SPECIAL DIAPHRAGM PUMPS**

High pressure, drum and split manifold



Besides our 4 standard series of double diaphragm pumps the Verderair range includes 3 special pump models for specific applications relevant in many industries and application areas.

### **Verderair VA High Pressure Diaphragm Pumps**

Double diaphragm pumps have a maximum air pressure rating of 8.4 bar. Verderair offer a series of high pressure pumps (up to 16 bar liquid pressure) with the same benefits and features as the reliable VA series of pumps.

Max. flow	300 l/min	Max. pressure	16 bar
-----------	-----------	---------------	--------

### **Verderair VA Drum Pumps**

For the emptying of chemicals from small barrels, containers, canisters and drums (approx. 200 l), a double diaphragm drum pump is a very good alternative for a conventional rod drum pump. Pumps are delivered with standard suction tube in several materials.

Max. flow	61 l/min	Max. pressure	7 bar
-----------	----------	---------------	-------

### **Verderair Diaphragm Pump with Split Manifold**

For the pumping of two liquids with one pump or for mixing two liquids with a 50-50 ratio.

Max. flow	2 x 30 l/min	Max. pressure	7 bar
-----------	--------------	---------------	-------





Quick distribution

**Logistic Center – Groningen, The Netherlands**

We have set up a 10,000 m<sup>2</sup> logistics center in Groningen, The Netherlands, aimed to centralize the distribution of Verderair Pumps in Europe. This ensures quick distribution of our pumps; In Europe even with “next day delivery” and to customers worldwide.

More than 2000 Verderair pumps and the necessary spares are available in the LCG to be shipped overnight.

To ensure a minimum disruption to your production process, we advise you to keep the necessary spares in stock.



**Fluid kit**



**Air kits**

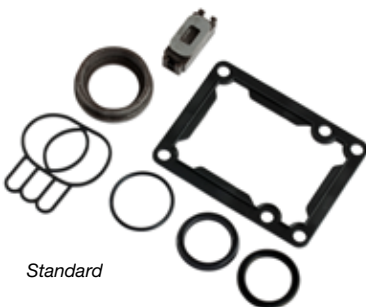

Standard



Quick Acting

## VERDERAIR: A **PUMP SOLUTION** FOR EVERY APPLICATION



### **Beverage industry**

*Yeast, diatomaceous earth, slurry, dregs, liquid hops, sugar, wine, fruit, corn syrup.*



### **Electroplating industry (Galvanics)**

*Solvents, electroplating baths, carrier fluids for ultrasonic washing, sulfuric nitric and acid washes, etching acids, acetone, polishing compound.*



### **Food industry**

*Brine, chocolate, vinegar, molasses, dog & cat food, vegetable oil, honey, animal blood, CIP liquid reparation.*



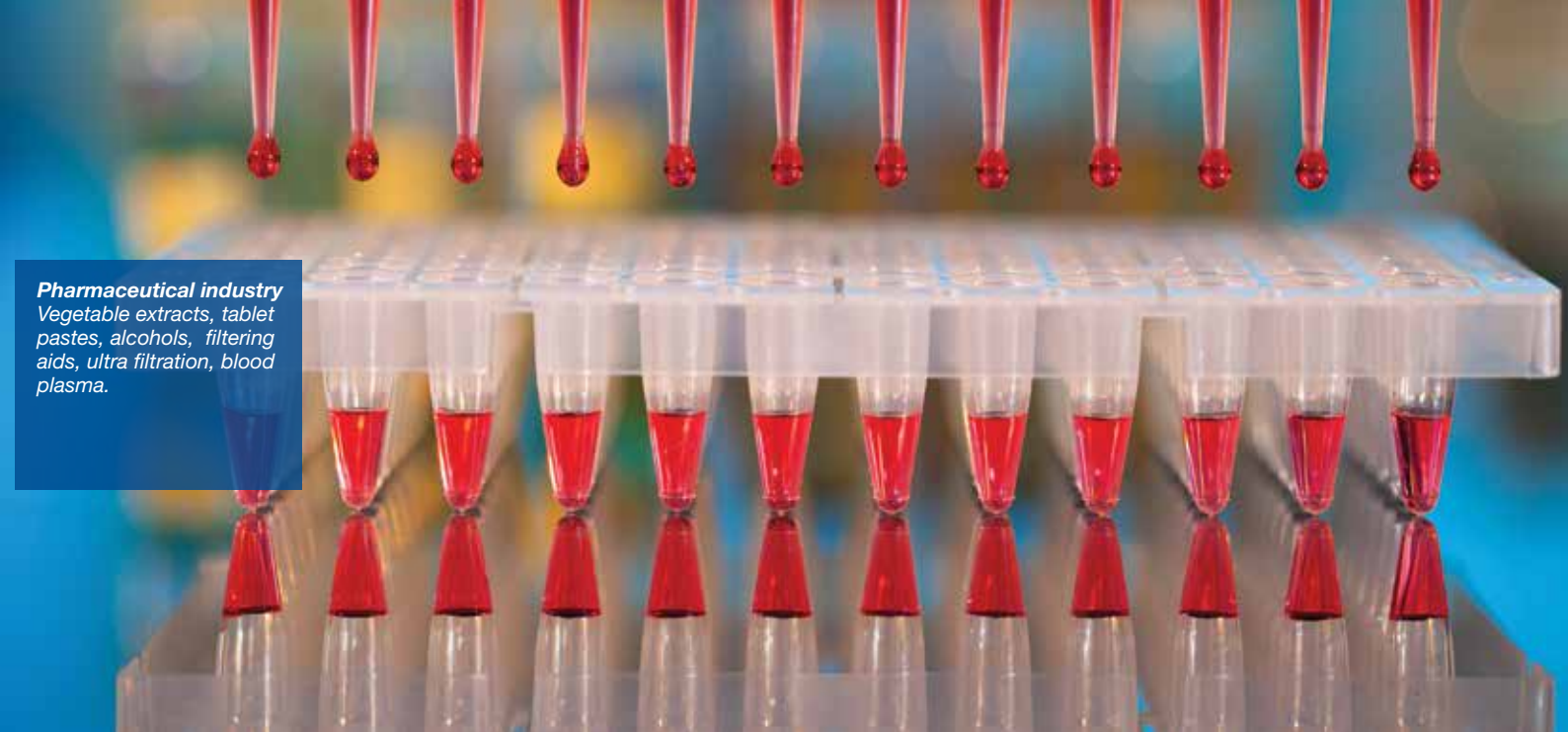

**Pharmaceutical industry**  
Vegetable extracts, tablet pastes, alcohols, filtering aids, ultra filtration, blood plasma.



**Paint and coatings industry**  
Resins, solvents, wood preservative stain, concrete paints, titanium dioxide slurry, dispersions, varnish cleaning baths.



**Solar power industry**  
Silicon dioxide slurry, HF, filter press applications, crystalline silicon, solar cells and panels, polishing, anti-reflective coating, electrical contacts and encapsulation.





**VERDERAIR**  
diaphragm pump  
**VA 40**

*Any questions? Visit our website  
[www.verderliquids.com](http://www.verderliquids.com).*



**VERDER B.V.**

Leningradweg 5  
NL-9723 TP Groningen

**MAIL** [verderair@verder.com](mailto:verderair@verder.com)  
**WEB** [www.verderliquids.com](http://www.verderliquids.com)

**AUSTRIA / BELGIUM / BULGARIA / CHINA / CROATIA / CZECH REPUBLIC  
GERMANY / DENMARK / FRANCE / HUNGARY / INDIA / ITALY / THE  
NETHERLANDS / POLAND / ROMANIA / SLOVAKIA / THAILAND / UNITED  
KINGDOM / USA / SERBIA / SLOVENIA / SOUTH AFRICA / SWITZERLAND**